



AH06 (optional mounting bracket for small, medium, and large CTs)



**⚠️ ⚠️ DANGER**

**HAZARD OF ELECTRIC SHOCK, EXPLOSION, OR ARC FLASH**

- Follow safe electrical work practices. See NFPA 70E in the USA, or applicable local codes.
- This equipment must only be installed and serviced by qualified electrical personnel.
- Read, understand and follow the instructions before installing this product.
- Turn off all power supplying equipment before working on or inside the equipment.
- Use a properly rated voltage sensing device to confirm power is off.
- DO NOT DEPEND ON THIS PRODUCT FOR VOLTAGE INDICATION**
- Only install this product on insulated conductors.

**Failure to follow these instructions will result in death or serious injury.**

A qualified person is one who has skills and knowledge related to the construction and operation of this electrical equipment and the installation, and has received safety training to recognize and avoid the hazards involved. NEC2011 Article 100  
No responsibility is assumed by Veris Industries for any consequences arising out of the use of this material.

**NOTICE**

- This product is not intended for life or safety applications.
- Do not install this product in hazardous or classified locations.
- The installer is responsible for conformance to all applicable codes.
- Mount this product inside a suitable fire and electrical enclosure.

**FCC PART 15 INFORMATION**  
NOTE: This equipment has been tested by the manufacturer and found to comply with the limits for a class A digital device, pursuant to part 15 of the FCC Rules. These limits are designed to provide reasonable protection against harmful interference when the equipment is operated in a commercial environment. This equipment generates, uses, and can radiate radio frequency energy and, if not installed and used in accordance with the instruction manual, may cause harmful interference to radio communications. Operation of this equipment in a residential area is likely to cause harmful interference in which case the user will be required to correct the interference at his own expense. Modifications to this product without the express authorization of Veris Industries nullify this statement.

Always observe all National and Local Codes during installation of this product.  
Provide a disconnect device to disconnect the H81xx from the supply source. Place this device in close proximity to the equipment and within easy reach of the operator, and mark it as the disconnecting device. The disconnecting device shall meet the relevant requirements of IEC 60947-1 and IEC 60947-3 and be suitable for the application. In the US and Canada, disconnecting fuse holders can be used.  
Provide overcurrent protection devices for supply conductors. Install per national or local regulations.  
If the equipment is used in a manner not specified by the manufacturer, the protection provided by the device may be impaired.

# H81xx

## Energy Meter

### Product Overview

The H81xx Series energy meter combines industrial-grade split-core current transformers and precision microprocessor-based metering electronics. It can detect phase reversal, eliminating load orientation concerns. The meter and current transformers are calibrated as a set, so the installer must match their serial numbers at the time of installation. The H8150 provides a control power voltage range of 90-132 VAC. The H8163 and H8167 provide an extended input control power voltage range (90-300 VAC).

The H8163 and H8167 models also have a pulse output compatible with building control systems and a phase loss output to protect equipment. All models include a slot to install a Modbus, BACnet, or Metasys communication board (sold separately). When equipped with this board and connected to a data acquisition system, the H8163 and H8167 can report energy and power diagnostic variables, including kWh, kW, PF, kVAR, Volts, and Amps.

### Product Identification

#### 120 VAC - 240 VAC (nom.); 90-132 VAC L-N; Display Only Output

Amps	One CT	Two CTs	Three CTs
100 Micro	H8150-0100-0-1	H8150-0100-0-2	H8150-0100-0-3
200 Mini	H8150-0200-1-1	H8150-0200-1-2	H8150-0200-1-3
300 Small	H8150-0300-2-1	H8150-0300-2-2	H8150-0300-2-3
400 Med		H8150-0400-3-2	H8150-0400-3-3
800 Med		H8150-0800-3-2	H8150-0800-3-3
800 Lg			H8150-0800-4-3
1600 Lg			H8150-1600-4-3
2400 Lg			H8150-2400-4-3

#### 120 VAC - 480 VAC (nom.); 90-300 VAC L-N; Pulse, Phase Loss, and Display Outputs

Amps	One CT		Two CTs		Three CTs	
100 Micro	H8163-0100-0-1	H8167-0100-0-1	H8163-0100-0-2	H8167-0100-0-2	H8163-0100-0-3	H8167-0100-0-3
200 Mini	H8163-0200-1-1	H8167-0200-1-1	H8163-0200-1-2	H8167-0200-1-2	H8163-0200-1-3	H8167-0200-1-3
300 Small	H8163-0300-2-1	H8167-0300-2-1	H8163-0300-2-2	H8167-0300-2-2	H8163-0300-2-3	H8167-0300-2-3
400 Med			H8163-0400-3-2	H8167-0400-3-2	H8163-0400-3-3	H8167-0400-3-3
800 Med			H8163-0800-3-2	H8167-0800-3-2	H8163-0800-3-3	H8167-0800-3-3
800 Lg					H8163-0800-4-3	H8167-0800-4-3
1600 Lg					H8163-1600-4-3	H8167-1600-4-3
2400 Lg					H8163-2400-4-3	H8167-2400-4-3

## Product Identification (cont.)

### Optional Comm Board (sold separately)

Model	Description
H8163-CB	Modbus® Communications Board for H81xx Series
H8186-CB	BACnet® Communications Board for H81xx Series
H8126-CB	Metasys® N2 Communications Board for H81xx Series (consult factory if ordering this item)

### Optional Accessory

Model	Description
AH06	Mounting Bracket Kit (fits the Small, Medium, and Large CTs only)

## Specifications

<b>INPUTS</b>	
<b>H8150</b>	90 to 132VAC line-to-neutral
<b>H8163, H8167</b>	90 to 300VAC line-to-neutral
<b>Frequency</b>	50/60 Hz
<b>ACCURACY</b>	
<b>System Accuracy</b>	±1% of reading from 2% to 100% of the CT current rating *
<b>Sample Rate</b>	1280 Hz
<b>OUTPUTS</b>	
<b>All Models</b>	1.2" x 3.8" (31 mm x 97 mm) viewing area, 160 segments, backlit LCD
<b>H8163 and H8167</b> PULSE OUTPUT PULSE RATE PULSE WIDTH PHASE LOSS ALARM OUTPUT	N.O., Opto-FET, 100mA@24VAC/DC 0.10, 0.25, 0.50, 1.00 kWh per pulse (jumper selectable) 200msec closed H8163: N.O. (opens on alarm, remains open while alarm persists); H8167: N.C. (closes on alarm, remains closed while alarm persists); Both H8163 and H8167: Opto-Fet, 100mA@24VAC/DC; Fixed threshold 25% below any other phase
<b>MECHANICAL</b>	
<b>Protection Class</b>	NEMA 1
<b>Insulation Class</b>	600 VAC **
<b>OPERATING CONDITIONS</b>	
<b>Operating Temperature Range</b>	0° to 50°C (32° to 122°F)
<b>Storage Temperature Range</b>	-40°C to 70°C (-40° to 158°F)
<b>Humidity Range</b>	0-95% RH, non-condensing
<b>Altitude of Operation</b>	0 to 2000 m
<b>ELECTRICAL SERVICES</b>	
<b>H8150</b>	120/240 VAC with neutral, 208Y/120 VAC line-to-neutral
<b>H8163, H8167</b>	Any Wye service in which the phase L-N voltage is ≤300VAC and the phase-to-phase voltage is ≤480 VAC nom. with neutral
<b>COMPLIANCE INFORMATION</b>	
<b>Agency Approvals</b>	UL 61010
<b>Installation Category</b>	Cat III, pollution degree 2

\* Meters and current transformers are calibrated as a set. To achieve this accuracy, match the serial numbers on the current transformers and the meter at the time of installation (does not apply to 100 A CTs).

\*\* Do not apply 600V class current transformers to circuits having a phase-to-phase voltage greater than 600V without adequate additional insulation between primary conductor and current transformers.

Dimensions

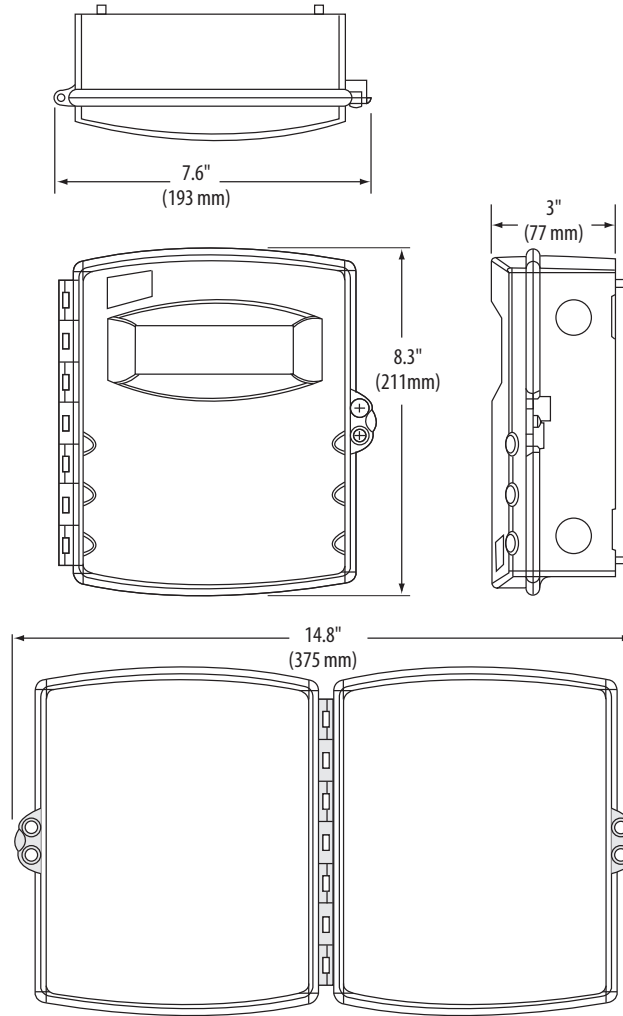

**MICRO**  
100 Amp

- A = 1.6" (40 mm)
- B = 0.7" (16 mm)
- C = 0.7" (16 mm)
- D = 1.2" (29 mm)
- E = 2.1" (53 mm)

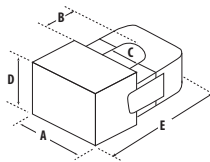

**SMALL**  
300 Amp

- A = 3.8" (95 mm)
- B = 1.5" (38 mm)
- C = 1.3" (32 mm)
- D = 1.1" (29 mm)
- E = 4.2" (107 mm)
- F = 4.8" (121 mm)

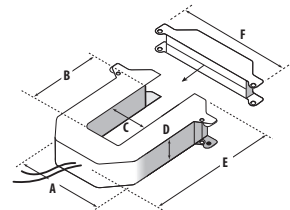

**MINI**  
200 Amp

- A = 2.6" (66 mm)
- B = 1.1" (28 mm)
- C = 0.8" (19 mm)
- D = 1" (27 mm)
- E = 2.9" (74 mm)
- F = 3.5" (90 mm)

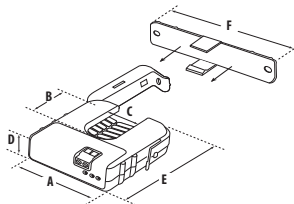

**MEDIUM**  
400/800 Amp

- A = 4.9" (124 mm)
- B = 2.9" (73 mm)
- C = 2.5" (62 mm)
- D = 1.1" (29 mm)
- E = 5.6" (141 mm)
- F = 5.9" (150 mm)

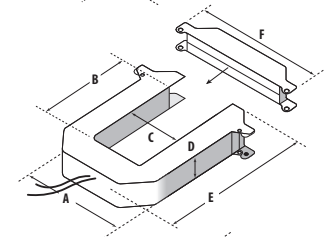

**LARGE**  
800/1600/2400 Amp

- A = 4.9" (124 mm)
- B = 5.5" (140 mm)
- C = 2.5" (62 mm)
- D = 1.1" (29 mm)
- E = 8.1" (207 mm)
- F = 5.9" (150 mm)

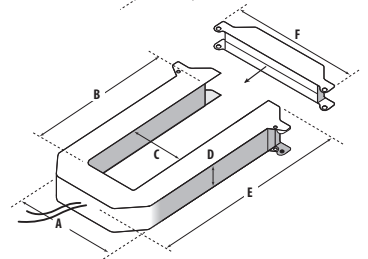

Product Diagram

H81xx Series Cover

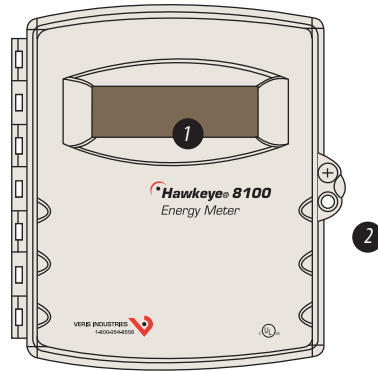

H8163/H8167 Inside and Board Layout

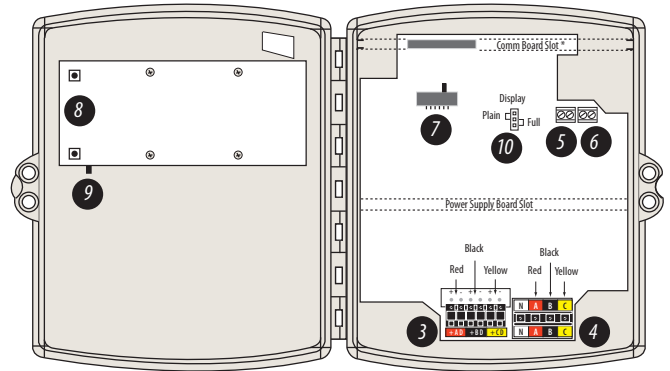

\* Comm board is optional and sold as a separate product.

H8150 Inside and Board Layout

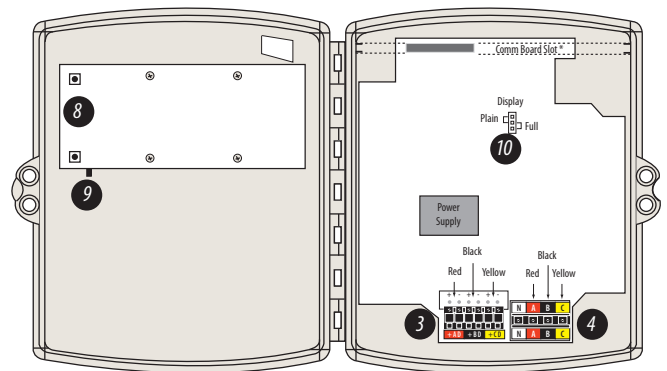

\* Comm board is optional and sold as a separate product.

1. Display. Large digit backlit LCD for data and diagnostics.
2. Security hasp.
3. Current transformer input terminals. These ensure that voltage lead and current transformer are properly matched (e.g. red to red).
4. Voltage input terminals. These ensure that voltage lead and current transformer are properly matched (e.g. red to red).
5. Pulse output terminals. These provide easy integration to existing control/data acquisition systems. (H8163 and H8167)
6. Phase loss output alarm. Alarm trips to protect equipment if phase voltage drops 25%. (H8163 and H8167)
7. Pulse rate selection switch. Set the pulse output at 0.1, 0.25, 0.50, or 1 pulse/kWh to match resolution requirements. (H8163 and H8167)
8. kWh reset. To reset the kWh counter, push both buttons at the same time and hold for 10 seconds. To reset kW max, push both buttons and hold for 5 seconds.
9. Backlight enabling jumper. Remove this jumper to disable lighting.
10. Plain/full display data jumper. 20 or 90 second display cycle.

Installation

**⚠️ Disconnect and lock out all power sources during installation and configuration.**

**⚠️ If making connections to the meter through more than one metallic conduit, use a bonding plate (Veris part number AH11 or equivalent) to prevent electric shock.**

1. Verify that the serial number on the meter matches the serial numbers on the current transformers (CTs). These are calibrated as a set, and mixing transformers with non-matching meters may damage the device when power is applied. The meter's serial number is printed on the label affixed to the inside of the front cover, and the CT serial number is on the CT label. If using 100 A CTs, serial number matching does not apply.

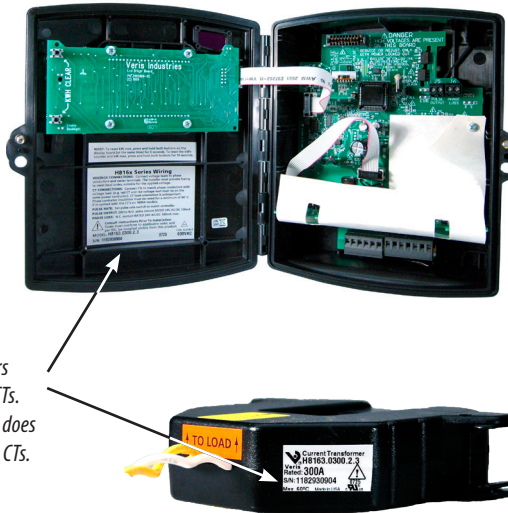

Match serial numbers between meters and CTs. Serial number matching does not apply if using 100 A CTs.

2. Mount the meter.
3. Attach the CTs to the conductors. Local code requirements may require a mounting bracket. For maximum accuracy, run the conductor through the center of the current transformer window.
4. *Optional step, per NEC and local regulations:* Attach external fuses (not included with the H81xx devices). Verify that the fuse rating is adequate for the applied voltage, with a current rating of 1/2 Amp (T) slow blow. Select fuses with a fault current rating that matches the power source rating.

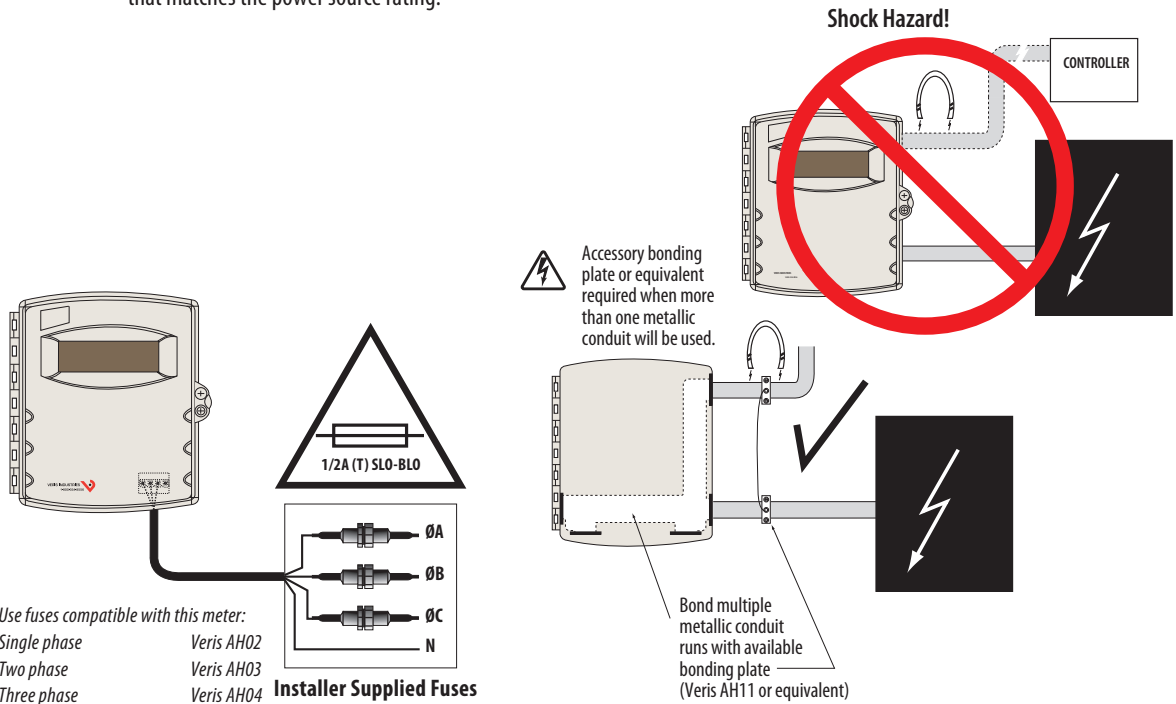

## Installation (cont.)

- Use color coding to attach current transformer (CT) leads to the input terminals (e.g. red labeled lead to red terminal). Polarity is indicated in the wiring diagrams, but the meter is not polarity sensitive. See the Wiring section.
- Use color coding to connect voltage leads to phase conductors (e.g. red transformer lead to red terminal). The meter is powered from the monitored source, so connect the voltage leads to a circuit that is normally left on. See the Wiring section.
- H8163 and H8167:** Connect the output terminals to the control/data acquisition system. The Pulse Output is normally open. For the H8163, the Phase Loss Output is normally open, and for the H8167, it is normally closed. Both are rated for 24 VAC/VDC@100 mA maximum. Ensure that the installation method and insulation ratings conform to local and national electrical codes.

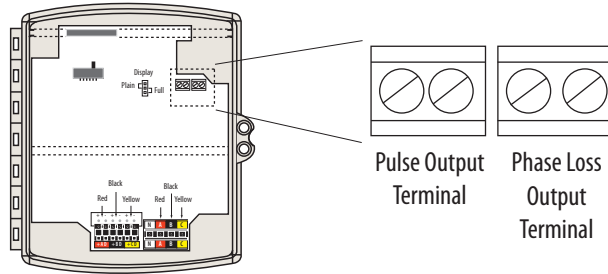

- Set the backlight enabling jumper as desired. Remove the jumper to disable the backlight.

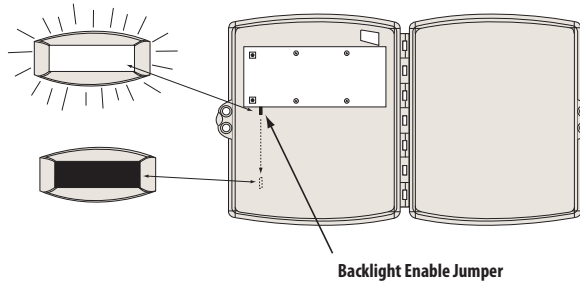

- Set the Display Data jumper for either Plain or Full settings. Plain mode cycles the display through five data elements (kW, max. kW since last reset, average PF, line-to-line voltage, and amps) for four seconds each. Full mode cycles through all of the data available in the meter. See the Information Reporting section for more details.

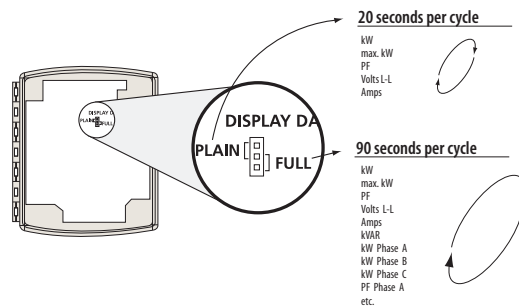

## Installation (cont.)

10. H8163 and H8167: Set the Pulse Rate selection switch to the desired output rate (kWh per pulse). Note that 0.1 is not valid for 1600 A systems, and 0.1 and 0.25 are not valid for 2400 A systems.

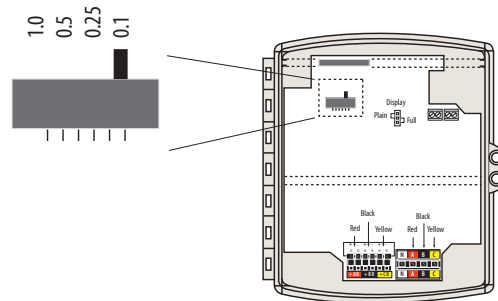

11. Secure the meter cover shut using a padlock, wire tie, or other locking device.
12. Apply power to the meter.
13. Check the display. At initial power-up, the meter checks each phase. If the phasing is correct, an OKAY message appears. If the phasing is incorrect, an error message indicates which color leads are not connected properly. Disconnect power before reconnecting leads.
14. Check the power reading. Expected power is estimated as follows:  
$$\text{kW} = \text{Volts(L-L)} * \text{Amps} * 1.732 * \text{PF} * 1000$$
$$\text{kW} = \text{horsepower} * 0.746$$
15. To reset the kWh accumulator to zero, press and hold the two pushbuttons on the inside of the meter cover for 10 seconds.
16. To reset the kW max. register, press and hold the two pushbuttons on the inside of the meter cover for 5 seconds.

Wiring

Connect the white wire to (-). Connect the red/black/yellow wire to (+).

*Typical 208/480VAC, \*\* 4-Wire, 3Ø Installation*

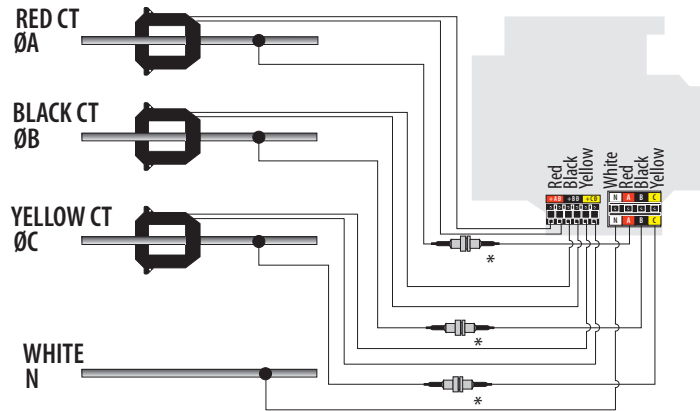

*Typical 240/120 VAC, 3-Wire, 1Ø Installation*

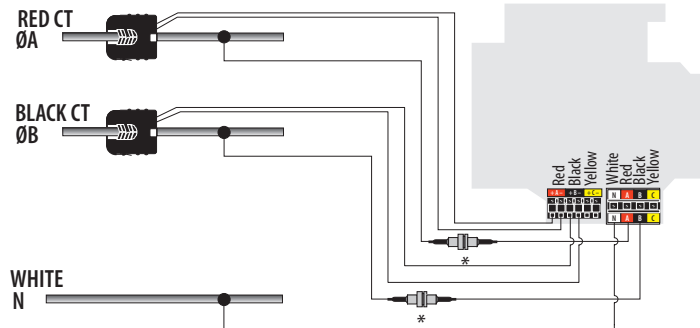

*Typical 120 VAC, 2-Wire, 1Ø Installation*

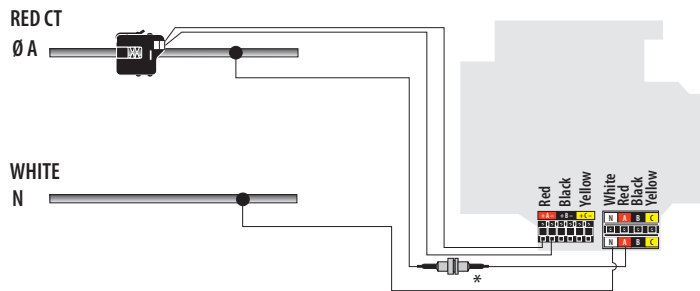

\* External fuse provided by installer (optional, per NEC and local regulations).

\*\* 480 VAC only applies to the H8163 and H8167.

## Alarms

The following messages remain on the lower display for the duration of an alarm condition:

Message	Explanation
Phase loss	The voltage on one phase is less than 75% of the voltage on any other phase. The displayed message indicates the problem phase.
Amps Over	The measured current is greater than 110% of the transformer range. The display message indicates the problem phase.
Volts Over	Volts A-C, B-C, or A-C is greater than 660VAC.* The displayed message indicates the problem phase.

\* The H8163 and H8167 are rated to 300 VAC L-N, and the H8150 is rated to 132 VAC L-N. Operation above these levels damages the device.

## Data Outputs

The H81xx continually reports kWh or MWh, depending on the total accumulated energy. A secondary display cycles through other parameters. The meter has two modes of display operation, depending on the setting of the Display Data jumper (J8) on the main circuit board. In Full Display mode, the meter cycles through all parameters. In Plain Display mode, the meter cycles through only the first five parameters as listed below:

kW  
 Max. kW  
 PF  
 Volts  
 Amps  
 kVAR  
 kW, phase A \*  
 kW, phase B \*  
 kW, phase C \*\*  
 PF, phase A \*  
 PF, phase B \*  
 PF, phase C \*\*  
 Volts, A-B \*\*  
 Volts, B-C \*\*  
 Volts, A-C \*\*  
 Volts, A-N \*  
 Volts, B-N \*  
 Volts, C-N \*\*  
 Amps, A \*  
 Amps, B \*  
 Amps, C \*\*

If the H81xx has a communication board installed, every 10th rotation of parameters displays an additional set of data values:

Pulse Rate \*\*\*  
 Address  
 Baud Rate  
 Parity  
 2/4 Wire

\* For meters with 2 or 3 current transformers.

\*\* For meters with 3 current transformers.

\*\*\* H8163 and H8167 only.

## Troubleshooting

Problem	Solution
No display	<ul style="list-style-type: none"> <li>· Check external fuses.</li> <li>· Verify that the display cable has not been disconnected during installation.</li> <li>· Verify voltage leads are properly connected.</li> </ul>
Reported power too low	<ul style="list-style-type: none"> <li>· Verify CTs and terminals are color-matched.</li> <li>· Check for phase loss.</li> <li>· Check external fuses.</li> </ul>
Reported power inaccurate	Verify meter and CTs have matching serial numbers (serial number matching does not apply if using 100 A CTs).
Accuracy not as specified	<ul style="list-style-type: none"> <li>· Verify CTs and terminals are color-matched.</li> <li>· Verify that no stray conductive materials (wire clippings, etc.) have shorted between the terminals.</li> </ul>
No Pulse output (H8163 and H8167)	<ul style="list-style-type: none"> <li>· Verify power is supplied in the range of 5-24 VAC/DC, with a max. load of 100 mA.</li> <li>· The pulse output interval is 200 msec; verify the controller accepts this signal as input.</li> </ul>
Pulse output wrong, display OK (H8163 and H8167)	Set the pulse rate switch and the controller to match kWh/pulse.
No Phase Loss output (H8163 and H8167)	Verify power is supplied in the range of 5-24 VAC/DC, with a max. load of 100 mA.
“bAd” appears in the display (H8163 and H8167)	Verify that the Pulse Rate slide switch is set to a valid value. 0.1 is not valid for 1600 A systems; 0.1 and 0.25 are not valid for 2400 A systems.
Accuracy not as specified	Verify current transformers and terminals are color-matched.